

TECHNICAL MANUAL

**DEMILITARIZATION
PROCEDURES**

FOR

**CHAPARRAL AIR DEFENSE
GUIDED MISSILE SYSTEM**

Change }
 No. 3 }

HEADQUARTERS
 DEPARTMENT OF THE ARMY
 Washington, D.C., 15 June 1999

DEMILITARIZATION PROCEDURES

FOR

CHAPARRAL AIR DEFENSE GUIDED MISSILE SYSTEM

TM 43-0003-16, 24 February 1986, is changed as follows:

1. The pages affected by this change, appearing in the following listing, are to be inserted in the manual immediately. Added or changed material on these pages is indicated by a vertical line in the margin.

Remove Pages

A/(B blank)
 i and ii
 3-1 thru 3-5/(3-6 blank)
 A- 1 /(A-2 blank)

Insert Pages

A/(B blank)
 i and ii
 3-1 thru 3-5/(3-6 blank)
 A- 1 /(A-2 blank)

2. This transmittal sheet should be filed in the front of the manual for reference purposes.

By Order of the Secretary of the Army:

Official:

DENNIS J. REIMER
General, United States Army
Chief of Staff

JOEL B. HUDSON
Administrative Assistant to the
Secretary of the Army
 9911805

Distribution:

To be distributed in accordance with the initial distribution number (IDN) 341606, requirements for TM 43-0003-16.

Change }
No. 2 }

HEADQUARTERS
DEPARTMENT OF THE ARMY
Washington, D.C., 10 October 1990

**DEMILITARIZATION PROCEDURES
FOR
CHAPARRAL AIR DEFENSE GUIDED MISSILE SYSTEM**

TM 43-0003-16, dated 24 February 1986, is changed as follows:

1. The pages affected by this change, appearing in the following listing, are to be inserted in the manual immediately. Added or changed material on these pages is indicated by a vertical line in the margin.

<i>Remove Pages</i>	<i>Insert Pages</i>
A/(B blank)	A/(B blank)
I, ii	i, ii
1-1/(1-2 blank)	1-1/(1-2 blank)
3-1 thru 3-3/(3-4 blank)	3-1 thru 3-51(3-6 blank)
NONE	A- 1/(A-2 blank)

2. This transmittal sheet should be filed in the front of the manual for reference purposes.

By Order of the Secretary of the Army:

CARL E. VUONO
General, United States Army
Chief of Staff

Official:

THOMAS F. SIKORA
Brigadier General, United States Army
The Adjutant General

Distribution:

To be distributed in accordance with DA Form 12-32, Unit, Direct Support and General Support Maintenance requirements for CHAPARRAL Missile System.

Change)
)
No. 1)

HEADQUARTERS
DEPARTMENT OF THE ARMY
Washington, DC, 18 May 1989

**DEMILITARIZATION PROCEDURES
FOR
CHAPARRAL AIR DEFENSE GUIDED MISSILE SYSTEM**

TM 43-0003-16, 24 February 1986, is changed as follows:

1. The pages affected by this change, appearing in the following listing, are to be inserted in the manual immediately. Added or changed material on these pages is indicated by a vertical line in the margin.

Remove Pages

None
2-7 thru 2-9/(2-10 blank)
3-1, 3-2

Insert Pages

A/(B blank)
2-7 thru 2-9/(2-10 blank)
3-1, 3-2

2. This transmittal sheet should be filed in front of the manual for reference purposes.

By Order of the Secretary of the Army:

CARL E. VUONO
General, United States Army
Chief of Staff

Official:

WILLIAM J. MEEHAN II
Brigadier General, United States Army
The Adjutant General

Distribution:

To be distributed in accordance with DA Form 12-32, Unit and Direct Support and General Support Maintenance Requirements for CHAPPARAL Missile System.

LIST OF EFFECTIVE PAGES

NOTE: On changed page, the portion of the text effected by the latest change is indicated by a vertical line in the margin of the page. Changes to illustrations are indicated by a pointing hand or shading in the changed area.

Original024 Feb 86 Change1 18 May 89
 Change2 10 Oct 90 Change3 15 Jun 99

Total number of pages in this publication is 22, consisting of the following:

Page No.	Change No.	Page No.	Change No.	Page No.	Change No.
A	3				
B blank	3	2-1 thru 2-7	0	3-1 thru 3-5	3
i and ii	3	2-8	1	(3-6 blank) deleted	3
1-1/(1-2 blank)	2	2-9/(2-10 blank)	1	A-1/(A-2 blank)	3

Zero in this column indicates an original page

DEMILITARIZATION PROCEDURES
FOR
CHAPARRAL AIR DEFENSE GUIDED MISSILE SYSTEM

REPORTING OF ERRORS AND RECOMMENDING IMPROVEMENTS

You can help improve this publication. If you find any mistakes or if you know of a way to improve the procedures, please let us know. Mail your letter, DA Form 2028 (Recommended Changes to Publications and Blank Forms) or DA Form 2028-2 located in the back of this manual direct to: Commander, U. S. Army Aviation and Missile Command, ATTN: AMSAM-MMC-LS-LP, Redstone Arsenal, AL 35898-5000. A reply will be provided to you.

You may also send in your comments electronically to our e-mail address: ls-lp@redstone.army.mil or by fax 256-842-6546/DSN 788-6546.

TABLE OF CONTENTS

	Paragraph	Page
CHAPTER 1. INTRODUCTION		
Scope	1-1	1-1
Maintenance Forms and Records	1-2	1-1
Authorization	1-3	1-1
Certification	1-4	1-1
Purpose of Demilitarization	1-5	1-1
Reporting Demilitarization	1-6	1-1
CHAPTER 2. METHODS OF DEMILITARIZATION		
Section I. Methods		
General	2-1	2-1
Burning	2-2	2-1
Cutting	2-3	2-1
Mutilating	2-4	2-1
Smashing	2-5	2-1
Welding	2-6	2-1
Detonating	2-7	2-1
Section II. Demilitarization by Detonation		
General	2-8	2-2
Preparing a Detonating Cord Firing System	2-9	2-2
Detonating Cord Misfires	2-10	2-3

TABLE OF CONTENTS - Continued

	Paragraph	Page
Dual Firing Systems	2-11	2-5
Priming Charges	2-12	2-5
Procedures for Detonating of CHAPARRAL Missile	2-13	2-5
Procedures for Detonating Disassembled Warheads, Guidance Control Sections, Seeker Sections, Target Detecting Devices and Safety and Arming Devices	2-14	2-8
Procedures for Burning of CHAPARRAL Rocket Motors	2-15	2-8
 CHAPTER 3. DEMILITARIZATION REQUIREMENTS FOR CHAPARRAL WEAPON SYSTEM		
 Section I. Missiles		
Guided Missile MIM-72 (all configurations)	3-1	3-1
Guided Missile Training M-30 and M33	3-2	3-1
 Section II. Carrier and Launching Station		
M730 Carrier	3-3	3-1
M-54 Launching Station (all configurations).....	3-4	3-1
 Section III. Test Equipment		
AN/TSM-96 Shop Equipment (all configurations)	3-5	3-3
IFF Subsystem Training Set (6920-01-070-3144)	3-6	3-3
AN/TSM-85 Test Set (all configurations)	3-7	3-3
 Section IV. Deleted		
Deleted	3-8	
Deleted	3-9	
 Section V. FLIR		
Afocal Assembly and Optical Imager	3-10	3-4
Operations	3-11	3-4
 APPENDIX REFERENCES		A-1

CHAPTER 1 INTRODUCTION

1-1. Scope.

with proper inspection and surveillance, or may obtain assistance from the activity turning in the property This manual provides additional technical instructions covering the methods and degree of demilitarization of surplus military items as required by DOD4160.21-NM-1. DOD 4160.21-M-1, which contains the basic information on demilitarization, should be used in conjunction with this manual. Where this manual conflicts with DOD 4160.21-M-1, the latter takes precedence. Contract or property disposal file for all items demilitarized.

1-2. Maintenance Forms and Records.

Department of the Army forms and procedures used for equipment maintenance will be those prescribed by DA PAM 738-750, The Army Maintenance Management Systems (TAMMS). The DA PAM is published in the Maintenance Management UPDATE. Units may subscribe to Maintenance Management UPDATE by submitting a completed 12-13.

1-3. Authorization.

Demilitarization of surplus military materiel shall be limited to that which the National Inventory Control Points (NICP) have identified as requiring demilitarization. Demilitarization of those items which are not normally physically accepted by a Property Disposal Officer (PDO) will be accomplished by the activity having physical custody of the property upon completion of all required utilization and donation screening. Such action will be coordinated with the PDO. Where appropriate, demilitarization of this property may be accomplished as a condition of sale, provided that there are effective controls and surveillance to assure proper demilitarization. Where the PDO is the custodian of the property and is unable

to perform the required demilitarization, the PDO may require demilitarization as a condition of sale, with proper inspection and surveillance, or may obtain assistance from the activity turning in the property.

1-4. Certification.

A certificate reading substantially as quoted below and signed by two qualified government representatives will be executed and placed in the applicable contract or property disposal file for all items demilitarized.

"I certify that (indicate items) were demilitarized in accordance with (cite specific instructions which were completed with, e.g., Defense Demilitarization Manual DOD 4160.21-M-1, TM 43-0003-16)."

1-5. Purpose of Demilitarization.

The purpose of demilitarization of equipment is to alter its characteristics to the extent necessary to preclude its unauthorized use, to destroy the military advantages inherent in the equipment, to render innocuous those items that are dangerous, to protect the national interest, and to preclude the compromise of security requirements.

1-6. Reporting Demilitarization.

Refer to AR 755-2 for instructions on the records required when non-classified items are demilitarized and reclassified from items to scrap. Refer to TB 9-298 for instructions on the records required when classified items are demilitarized. For accounting purposes, a signed and countersigned certificate (see para 1-4 above) will accompany all demilitarized equipment or material turned in to the PDO for disposition. Demilitarization certificates for classified equipment or materiel are covered in AR 380-5.

Change 2 1-1/(1-2 blank)

CHAPTER 2 METHODS OF DEMILITARIZATION

Section I. METHODS

2-1. General.

This chapter defines methods, describes procedures and precautions, and lists the equipment required to perform the operations prescribed in the following chapters. Alternate methods may be employed when they will achieve equivalent results with equal efficiency and without added safety hazards. It is intended that this chapter supplement the instructions, procedures, and precautions contained in TM 9-1300-206 and AMCR 385-100. Only those special instructions, procedures and precautions applicable to the destruction of Chaparral items are contained herein.

2-2. Burning.

A clean-burning, flammable material such as gasoline should be used for burning. Burning should be done in an approved area. Since fire alone may not achieve the damage expected, the material being demilitarized should be inspected following the burn to ensure adequacy of the operation.

2-3. Cutting.

Cutting may refer to two different types of operation:

a. Cable and like items should be severed completely, using a wire cutter, axe, hacksaw, or equivalent.

b. Cutting may also be accomplished by using an acetylene or arc-welding torch. The following safety precautions must be observed during torch cutting.

(1) Due to the probability of high order and low order explosions, torch cutting is inherently hazardous. Closed chambers such as tanks, accumulators, recoil mechanism components, aircraft struts, hollow rods or hollow valve stems. (Even though the components are not under pressure or have had small holes drilled in them.)

(2) An explosion may result from the heat of the torch vaporizing oil, paint or components inside the component. In addition, gases from the cutting torch

may enter the hollow space, either adding to or creating a highly explosive condition.

(3) In torch cutting, it must be realized that components under spring pressure may become dangerous upon sudden release of the spring-holding construction.

(4) Safety precautions are also necessary where flammable materials or materials such as sodium and magnesium are involved in the torch cutting operation.

(5) Precautions against the hazards of torch cutting should include isolation of the working area, a technical knowledge of the construction of the component to be torch cut, and remote control of the cutting operation.

2-4. Mutilating.

Mutilating is damaging an item beyond repair by the use of a hammer, sledgehammer, crowbar, torch, or other appropriate tool. Mutilating applies to solid objects that cannot be smashed.

2-5. Smashing.

Smashing is the complete crushing of a relatively fragile item by the use of a hammer, sledgehammer, or other appropriate tool.

2-6. Welding.

Welding is the welding of designated sections together to render the equipment permanently inoperative, or to the application of a welded bead at a key point to obtain the same result. Either acetylene or arc-welding equipment may be used.

2-7. Detonating.

Detonating is the complete destruction of material using high explosives. Refer to AMCR-385-100 and TM 9-1300-206 for location, personnel safety and equipment requirements.

Section II. DEMILITARIZATION BY DETONATION

2-8. General.

a. The number of components that may be demilitarized at any one time shall be limited to safe and efficient quantities. Only one rocket motor or intact missile may be demilitarized in area at any Preparing a Detonating Cord Firing System one time.

b. The destruction site must be a minimum distance of 2,400 feet from inhabited buildings, public railways, public highways, magazines, and operating buildings as outlined in AMCR 385-100 or TM 9-1300-206.

c. The area around the site must be cleared of dry grass, leaves, and other flammable materials for a radius of 200 feet.

d. Explosive items awaiting demilitarization will be stored not less than intraline-distance from the site and will be protected against accidental ignition by combustible material.

e. Local procedures shall be prepared by commands, installations, and establishments having a Chaparral missile explosive component demilitarization responsibility. These procedures should be tailored to the location, facilities, and equipment to be utilized and must be approved by proper authorities prior to implementation.

f. Personnel involved in the detonation of class V components will be instructed as to their specific duties. This instruction will be conducted prior to participation in detonation operations by the person responsible for the demilitarization activity.

g. Personnel concerned with any phase of demilitarization of class V components should be thoroughly familiar with the provisions of TM 9-1375-213-12, FM 5-25, and other existing directives and regulations as applicable. Destruction of explosive material will never be attempted by inexperienced or untrained personnel.

h. The number of persons engaged in the destruction of class V items, at any one operation, will be the minimum necessary for a safe and efficient operation. Personnel limits should be consistent with the amount of work to be done; under no circumstances should one person be permitted to work in an explosive

operation unobserved.

i. Misfires should not be investigated for at least 30 minutes after failure occurs. Instructions contained in TM 9-1375-213-12 and FM 5-25 should be followed when investigating any type of misfire during demilitarization operations.

2-9. Preparing a Detonating cord Firing System (figure 2-1).

A detonating cord firing system is probably the most versatile and easily installed firing system for explosives.

a. An electric system consisting of an electric power source or a nonelectric blasting cap initiated by a time fuze and igniter is used to initiate detonating cord. For detailed procedures, refer to TM 9-1375-213-12 and FM 5-25.

b. The blasting cap, electric or nonelectric, is attached to a point six inches from the free end of the detonating cord by numerous wraps of string, wire, cloth or tape.

c. A detonating cord clip (figure 2-2) or square knot pulled tight is used to splice the ends of detonating cord. At least a 6-inch length should be left free at both sides of the knot (figure 2-3). When fabric is used to cover the detonating cord, the fabric must not be removed. The knot may be placed in water or in the ground but the cord must be detonated from a dry end.

d. *Branch Line Connections.* A branch line is fastened to a main line by means of a clip (figure 2-4) or a girth hitch with one extra turn (figure 2-5). The angle formed by the branch line and the cap end of the main line should not be less than 90 degrees from the direction from which the blast is coming; at a smaller angle, the branch line may be blown off the main line without being detonated. At least 6 inches of the running end of the branch line is left free beyond the tie.

e. A ring main is made by bringing the main line back in the form of a loop and attaching it to itself with a girth hitch with one extra turn (figure 2-5).charges. The ring main makes the detonation of all charges more positive because the detonating wave approaches the branch lines from both directions one break in the ring main. Branch line connections should be made perpendicular to the ring main.

Kinks in lines should be avoided, and curves and angles should not be sharp. Any number of branch lines may be connected to the ring main, but a branch line is never connected at a point where the ring main is spliced. In

making detonating cord branch line connections, avoid crossing lines. However, if crossing lines are necessary, be sure to have at least one foot of clearance at all points between the detonating cords; otherwise, the cords will cut each other and destroy the firing system.

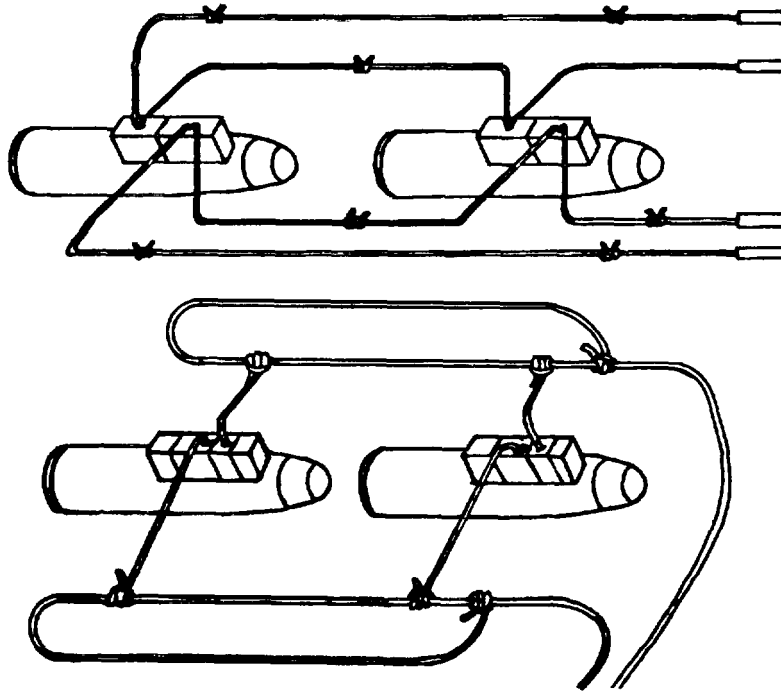

Figure 2-1. Examples of detonating cord ring main.

2-10. Detonating Cord Misfires.

a. Failure of Nonelectric Blasting Cap. If a non-electric blasting cap attached to detonating cord fails to function, delay the investigation for at least 30 minutes. Then cut the detonating cord main line between the blasting cap and the charge, and fasten a new blasting cap on the detonating cord.

b. Failure of Electric Blasting Cap. If an exposed electric blasting cap fastened to detonating cord fails to fire, disconnect the blasting machine immediately and investigate. Test the blasting circuit for any breaks or short circuit. Short the firing wire leads before leaving firing position to correct the problem. If necessary, replace the original blasting cap.

c. Failure of Detonating Cord. If detonating cord fails to function at the explosion of an exposed electric

or non-electric blasting cap, investigate immediately. Attach a new blasting cap to the detonating cord taking care to fasten it properly.

d. Failure of branch Line. If The detonating cord main line detonates but a branch line fails, fasten a blasting cap to the branch line and fire it separately.

e. Failure of Charge to Explode. If the charge is above ground, and the detonating cord leading to a charge detonates but the charge fails to explode, delay investigation until it is certain that the charge is not brining. If the charge is in the ground, wait 30 minutes. If the charge is intact insert a new primer. If the charge is scattered by the detonation of the original detonating cord, reassemble as much of the original charge as possible, place a new charge if necessary and reprime. Make every attempt possible to recover all explosives scattered by misfire.

Figure 2-4. Detonating cord clip.

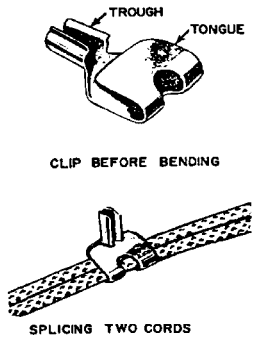

Figure 2-2. Detonating cord clip.

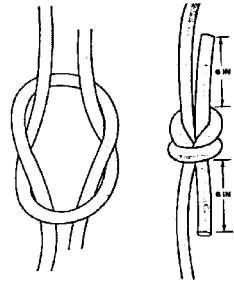

Figure 2-3. Square knot connections.

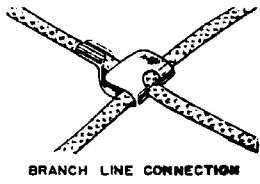

Figure 2-2. Detonating cord clip.

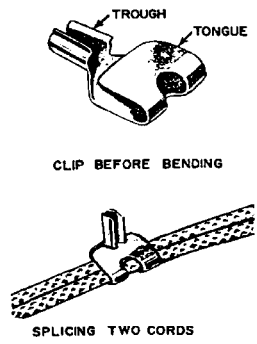
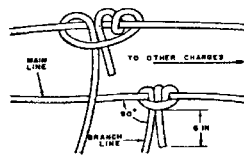

Figure 2-2. Detonating cord clip.

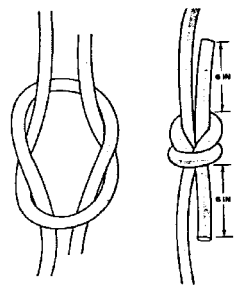
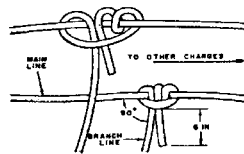
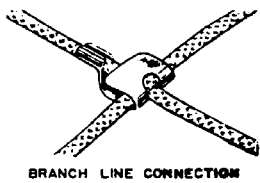

Figure 2-3. Square knot connections.



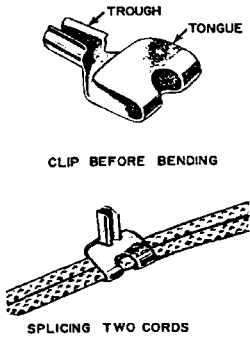

Figure 2-2. Detonating cord clip.

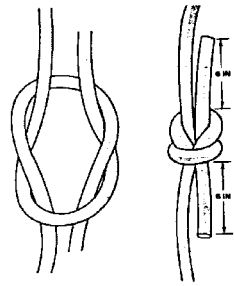

Figure 2-3. Square knot connections.

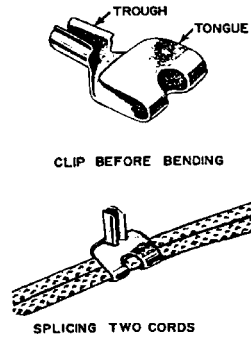

Figure 2-2. Detonating cord clip.

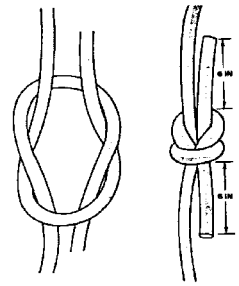

Figure 2-3. Square knot connections.

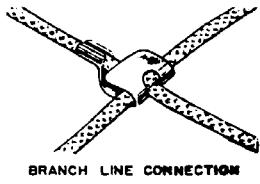

Figure 2-3. Square knot connections.

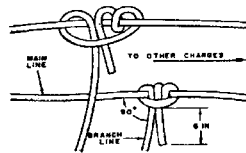
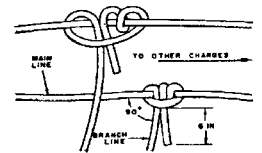
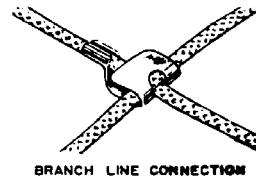

Figure 2-5. Girth hitch with one extra turn.



2-11. Dual Firing Systems.

a. There is always a certain amount of danger to personnel investigating misfires. Since dual priming increases the probability of successful firing, it should be used whenever possible. Dual priming consists of two complete systems independent of each other, and each capable of firing the same charge. It can be two electric systems, two nonelectric systems, or an electric and nonelectric system.

b. The nonelectric dual firing system consists of two independent nonelectric systems for firing a single charge or set of charges. If two or more charges are to be fired simultaneously, two detonating cord ring mains are laid out, and a branch line from each charge is tied into each ring main.

c. The electric dual firing system consists of two independent electric circuits, each with an electric blasting cap in each charge, so that the firing of either circuit will detonate all charges. The firing wires of the two circuits should be kept separated so that both will not be cut by a single fragment. The firing points should also be at two separate locations.

d. The combination dual firing system uses an electric and nonelectric firing system. Each charge is primed electrically and nonelectrically. Both the electric and nonelectric systems must be entirely independent of each other. The nonelectric system must be fired first.

2-12. Priming Charges

To prime plastic explosives with detonating cord, (TM 9-1375-213-12) form either of the two knots shown in figure 2-6. Insert the knot into the block of explosive or a molded piece of explosive as shown. In either case, ensure that there is at least 1/2 inch of explosive on all sides of knot. Alternate methods of priming explosives are found in TM 9-1375-213-12.

2-13. Procedure for Detonation of CHAPARRAL Missile.

a. Equipment/Supply Requirements.

(1) Handling equipment approved in accordance with AMCR385-100 and TM 9-1300-206.

(2) Flame resistant coveralls, safety shoes, and eye protection(i.e. safety glasses).

(3) Detonating cord.

(4) Galvanometer

- (5) Common hand tools
- (6) Explosive, TNT, or equivalent.
- (7) Blasting caps, electric, No. 8, NSN 1375-00-028-5224, or equivalent.

NOTE

Alternate methods of demolition may be used; however, strict compliance of the provisions in AMCR 385-100 and TM 9-1300-206 must be observed.

b. In the event that the warhead cannot be disassembled from the motor, the following procedure is to be used. Place the missile in an approved pit at least four feet deep, trench or site located in accordance with requirements of paragraph 2-8b. The missile shall be pointed in the direction which that would cause the least amount of damage in case of accidental ignition of the rocket motor. Sand bags may be used to position items and prevent movement.

c. Place the recommended quantities of TNT or plastic explosives(PE) as shown in figure 2-7. Secure the charges with masking tape.

d. Refer to paragraph 2-9 and prepare detonating cord firing system. Tape detonating cord to body of the missile.

e. cover missile with cardboard or sheets of plastic, then with at least two feet of dirt.

f. Attach blasting cap, electric or nonelectric, to a point six inches from the free end of the detonating cord (TM 9-1375-213-12).

WARNING

- Assure all personnel have been evacuated to a safe location prior to making connections and detonations.

- In case of misfire, personnel will not return to the point of detonation for at least 30 minutes, after which not more than two qualified personnel will be permitted to examine a misfire(AMCR 385-100).

g. Detonate using one of the following methods:

(1) An electric firing system (figure 2-8) consisting of a blasting cap, initiated by a blasting machine or other power source.



OVERHAND KNOT

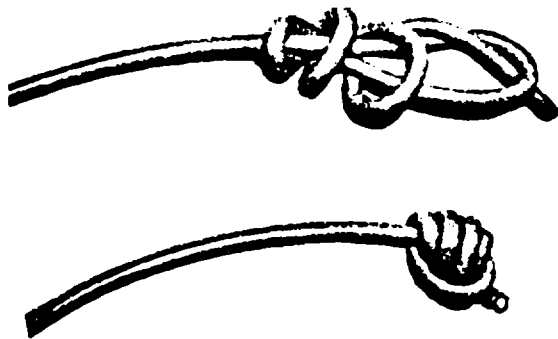
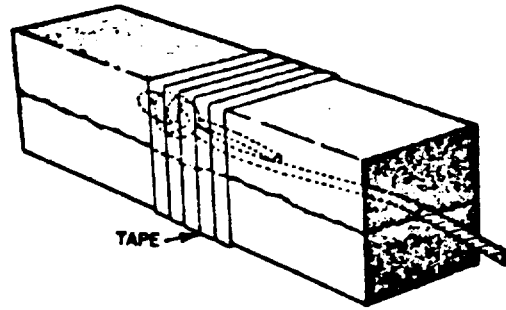

TRIPLE ROLL KNOT

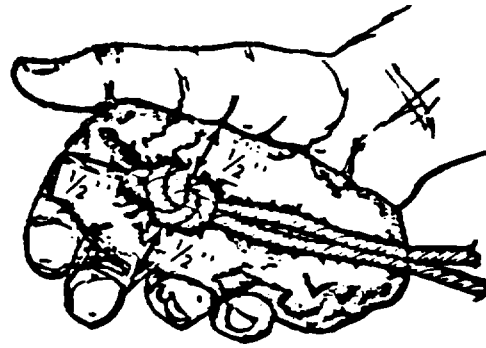
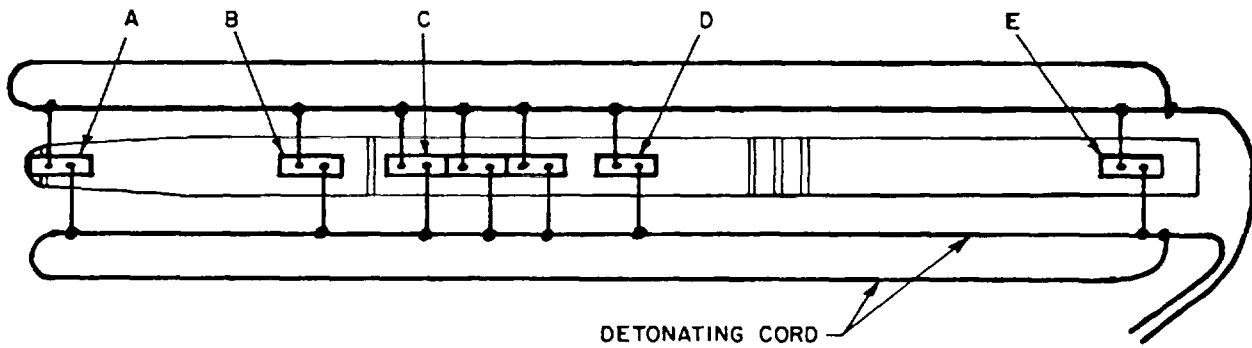

Figure 2-6. Detonating cord priming of plastic explosives.



A.	.5 lbs. TNT or PE	Guidance Control Section
B.	.5 lbs. TNT or PE	Gas Generator Assembly
C.	1.5 lbs. TNT or PE	Warhead
D.	.5 lbs. TNT or PE	Motor Forward
E.	.5 lbs. TNT or PE	Motor Aft
	3.5 lbs. TNT or PE	TOTAL

Figure 2-7. Arrangement of Detonating Charges for Demolition of One Chaparral Missile.

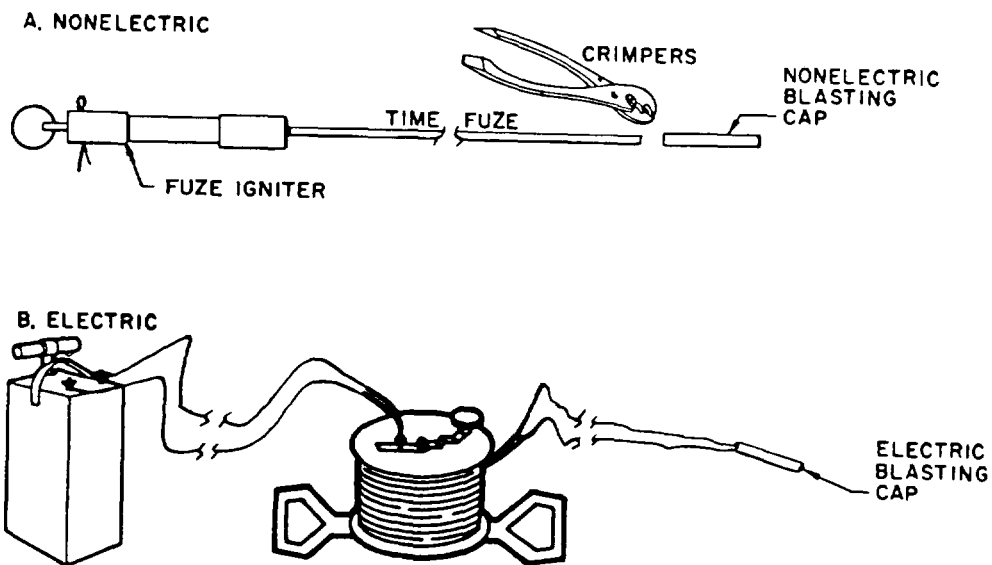

Figure 2-8. Initiation Systems.

(2) A nonelectric firing system consisting of a fuze igniter and a length of time-blasting fuze and non-electric blasting cap used to initiate detonating cord.

2-14. Procedures for Detonating Disassembled warheads, Guidance Control Sections, Seeker Section, Target Detecting Devices and Safety and Arming Devices.

NOTE

The following procedures are for the destruction of one item. The amount of material to be destroyed at one time depends on the facility's capacity and environmental restrictions. The range officer will decide the quantity to be destroyed.

a. Equipment/Supply Requirements.

(1) Handling equipment approved in accordance with AMCR 385-100 and TM 9-1300-206.

(2) Flame resistance coveralls, safety shoes and eye protection (i., safety glasses)

(3) Detonating cord.

(4) Galvanometer.

(5) Common hand tools.

(6) Explosive TNT, or equivalent.

(7) Blasting caps, electric, No. 8, NSN 1375-00-028-5224, or equivalent.

b. Place item(s) in approved pit or site at least four feet deep located in accordance with requirements of AMCR385-100 and TM 9-1300-206.

c. Place items to be destroyed in a container to prevent items from moving while covering the pit.

d. Place an adequate amount of explosives (see TM 9-1325-275-12) for destruction of one item or for destruction of multiple items.

e. refer to paragraph 2-9 and prepare a detonating cord firing system. Tape detonating cord to body of item to be destroyed.

f. cover material with cardboard or sheets of plastic, then with at least two feet of dirt.

g. Attach blasting cap, electric or nonelectric, to a point six inches from the end of the detonating cord in accordance with TM 9-1375-213-12.

WARNING

Assure all personnel have been evacuated to a safe location prior to making connections and detonations. In case of misfire, personnel will not return to the point of detonation for at least 30 minutes, after which not more than two qualified personnel will be permitted to examine a misfire (AMCR 385-100).

h. Detonate using one of the methods in paragraph 2-13g.

2-15 Procedures for Burning of Chaparral rocket Motors.

The following procedures are to be done only at depot level.

a. The following general safety requirements shall be followed during rocket motor demilitarization:

(1) Operating personnel will be kept at a minimum required to perform a safe and efficient operation.

(2) More than one rocket and ignitor may safely be demilitarized at any one time provided the local organization performing the demilitarization possesses adequate space, the capability, and local procedures allow it.

(3) Under no condition will the motor be handled roughly, tumbled, dropped or dragged.

(4) The motor casing will be grounded throughout the entire operation.

(5) The operators will wear flame resistant coveralls.

(6) Good housekeeping will be maintained at all times.

WARNING

Disconnect firing wires before returning to burning pit.

(7) In case of misfire, personnel shall not return to the point of initiation for at least 30 minutes, after which not more than two qualified persons shall be permitted to examine the misfire at a time.

(8) Wait at least 15 minutes after firing before returning to burning pit. This allows adequate time for dissipation of smoke and gases.

(9) The rocket motor shall be kept pointed in a direction that would cause the least damage in case of accidental ignition.

b The following tools and equipment will be needed to perform demilitarization procedures on the rocket motor

- (1) Equipment for digging a hole.
- (2) Approved handling equipment in accordance with AMCR-385-100 and TM 9-1300-206.
- (3) Flame-resistance coveralls, safety shoes and eye protection (i.e. safety glasses).
- (4) Detonating cord.
- (5) Galvanometer.
- (6) Blasting machine.
- (7) Common hand tools.
- (8) Blasting caps, electric, No. 8, NSN 1375-00-028-5224 or nonelectric equivalent.
- (9) Igniter, consisting of 1/2 pound of grade 3 black powder, electric squib or split end of a length of safety fuze with leads approximately 12 feet long and bag.

c. Prepare a hole perpendicular to the surface of the ground six inches in diameter and approximately five and one-half feet deep.

d .Refer to DMWR 9-6920-585/9 and disassemble the rocket motor. Dispose of the igniter by placing it upon a combustible layer of material and burning.

WARNING

Death or injury could result if motor is not placed forward end down and aft end up in hole.

e. Carefully place the motor in the hole with the aft end up. Approximately four to six inches of motor should be above ground level. Loosely pack the dirt around the motor.

f Prepare an initiating charge (figure 2-9) using a minimum of 1/2 lb. black powder (1) or small grain smokeless propellant in a bag. Place an electric squib (2) or the split end of a length of safety fuze into the bag (3) in direct contact with the powder. Connect the squib (2) in parallel to lead wires approximately 12 feet long with the end of the lead wires shorted by being twisted

together. Secure the bag (3) to the end of the motor in direct contact with the motor grain.

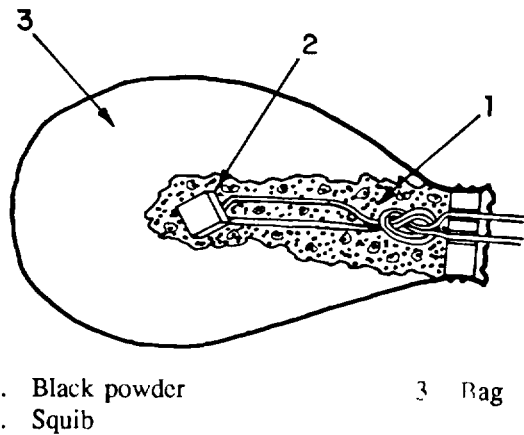

Figure 2-9. Initiating charge.

WARNING

Assure all personnel have been evacuated to a safe location prior to making connections and detonations.

In case of a misfire, personnel will not return to the point of detonation for at least 30 minutes, after which not more than two qualified personnel will be permitted to examine a misfire (AMCR 385-100).

g. Attach firing pin and initiate the charge using procedures for the squib or nonelectric procedures for the safety fuze.

h. The rocket motor tube and igniter shall be thoroughly inspected to assure that all explosives have been removed. Mutilate or smash rocket motor tube and igniter prior to releasing the components to DPPO.

CHAPTER 3

DEMILITARIZATION REQUIREMENTS FOR CHAPARRAL WEAPON SYSTEM

Section I. MISSILES

3-1. Guided Missile MIM-72 (all configurations).

Safety and Arming Device

Refer to TMs 9-1410-585-24P, 9-1410-586-24P, and 9-1410-587-24P (FMS), for physical location and identification of items.

a. In the event that MIM-72 cannot be disassembled, demilitarize entire MIM-72 by detonating (para 2-13).

b. The preferred method of demilitarization is to remove the following key components from MIM-72 missile and demilitarize in accordance with applicable procedures in paragraph c through h below.

Nomenclature

- Guidance Control Section (GCS)
- Seeker Section
- Target Detecting Device (TDD)
- Warhead
- Motor

c. *Guidance Control Section (GCS)*. Destroy by detonating (para 2-14).

d. *Seeker Section*. Destroy by detonating (para 2-14).

e. *Target Detecting Device (TDD)*. Destroy by detonating (para 2-14).

f. *Warhead*. Destroy by detonating (para 2-14).

g. *Motor*. Destroy by burning (para 2-15).

h. *Safety and Arming Device*. Destroy by detonating (para 2-14).

i. Prepare appropriate demilitarization and decontamination certificates (para 1-4).

3-2. Guided Missile Training M-30 and M33.

No demilitarization is required. Dispose of as scrap.

Section II. CARRIER AND LAUNCHING STATION

3-3. M730 Carrier.

Remove launching station from carrier and report the carrier to USATACOM for disposition instructions.

3-4. M54 Launching Station (all configurations)

Demilitarization of the Launching Station will consist of removing key items identified in the following paragraphs. Refer to TM 9-1440-1585-24P for physical location and identification of items and TM 9-1440-1585-20-2 (M54, M54A1) or TM 9-1440-2585-20-3 (M54A2) for complete disassembly instructions.

a. Remove the control box assembly (10233092). Destroy and dispose of accordingly.

b. Relieve hydraulic pressure, then drain the hydraulic tank.

c. Remove the antenna AS-1729/VRC and report to appropriate commodity manager for disposition instructions.

d. Remove CPE-D5-19-1785 and destroy and dispose of accordingly.

e. Remove the local control unit (C2329GRA39), receiver transmitter (RT-5241VRC), and radio receiver R-442/VRC, and interrogator kit and report to appropriate commodity manager for disposition instructions.

f. Remove IFF system, signal processor (13153340), receiver power supply (13153177), tracking signal processor (13153211), antenna (13059557), and report to appropriate commodity manager for disposition.

WARNING

Vacuum tube is used in this equipment. The cathode-ray tube (CRT) is highly vacuumized and may implode when broken. Beware of flying glass particles upon implosion. Avoid breathing the gases released when a tube is broken. When handling CRTs or equipment containing CRTs, wear protective gloves, apron, and face mask to minimize or avoid injury.

g. Remove the video display panel 13153172. Remove the following hazardous item (CRT) and dispose of accordingly.

Assembly Part Number	Tube #/Position
13153172	13153510

h. Remove the control panel (13059302) and mount control (13059303) and destroy and dispose of accordingly.

i. Remove the following hazardous items (batteries) and dispose of accordingly.

Assembly Part Number	Item
13006290	M535000-3
13059342	M535000-3
1322079	M535000-3

j. Remove the guided missile launchers (11072549). Destroy and dispose of accordingly.

k. Drain LH and RH fuel tanks (11072233 and 11072250).

l. Evacuate freon from air conditioner in accordance with local procedures.

WARNING

RADIOACTIVE MATERIAL

The antireflective coating on the infrared optics contains thorium fluoride which is radioactive. The only potential hazard involves ingestion (swallowing or inhaling) of the coating material. Dispose of broken lenses, etc. in accordance with AR 385-11. See Section V for special handling instructions.

m. Relieve the air pressure on the FLIR Air Purifier. Remove the FLIR receiver assembly (13153181/13229849).

(1) Remove the following hazardous item (optical imager) from the scanner optics assembly and report to appropriate commodity manager for disposition instructions.

Assembly Part Number	Item
SM-D-657725	optical imager

(2) Remove the AFOCAL lens (13152507) from receiver assembly. Demilitarize optical imager as specified in Section V.

n. Remove camera assembly (13152521) from the sensor assembly. Remove the following hazardous item (Electron Tube) and dispose of accordingly.

Assembly Part Number	Tube #/Position
13153492-1	Electron Tube

o. Remove name plates and obliterate identification markings from chassis demilitarized. Remove nameplates from major items.

p. Prepare the appropriate certificates per DOD 4160.21-M-1.

Section III. TEST EQUIPMENT**3-5. AN/TSM-96 Shop Equipment (all configurations).**

Demilitarization of the Shop Equipment will consist of removing key items identified in the following paragraphs. Refer to TM 9-4935-1585-24P for physical location and identification of items.

a. Remove the air conditioner and report to appropriate commodity manager for disposition instructions.

b. Remove the control indicator assemblies (10234411/13143361, 10233569 and 10233699/13143322) and demilitarize by crushing.

WARNING

The thermal sight collimator contains a glass lens. Beware of glass particles present when lens is broken.

c. Remove the thermal sight collimator and demilitarize by crushing.

WARNING

Vacuum tube is used in this equipment. The cathode-ray tube (CRT) is highly vacuumized and may implode when broken. Beware of flying glass particles upon implosion. Avoid breathing the gases released when a tube is broken. When handling CRTs or equipment containing CRTs, wear protective gloves, apron, and face mask to minimize or avoid injury.

d. Remove the display unit (MIS-36224) and demilitarize by crushing.

e. Remove the multimeter (23238344), oscilloscope (13238387) and counter (13238255) and turn in as commercial off the shelf test equipment.

f. Remove the power oscillator (13238256) and demilitarize by crushing.

g. Prepare the appropriate demilitarization documentation per DOD 4160.21-M-1.

3-6. IFF Subsystem Training Set (6920-01-070-3144).

Demilitarization of the IFF training set will consist of removing key items identified in the following paragraphs. Refer to TM 9-4935-1587-24P for physical location and identification of items.

a. Remove the KIRIATSEC and KIK18TSEC and demilitarize by crushing.

b. Prepare the appropriate demilitarization documentation per DOD 4160.21-M-1.

3-7. AN/TSM-85 Test Set (all configurations)

Demilitarization of the AN/TSM-85 will consist of removing key items identified in the following paragraphs. Refer to TM 9-4935-1587-24P for physical location and identification of items.

a. Remove the electronic component assembly (10233114/13142751) and demilitarize by crushing.

b. Prepare the appropriate demilitarization documentation per DOD 4160.21-M-1.

3-8. Deleted

3-9. Deleted

Section IV. Deleted

Section V. FLIR

3-10. Afocal Assembly and Optical Imager.

a. The following equipment is required for demilitarization of the afocal assembly, NSN 1430-01-104-9750, and optical imager, NSN 5855-01-082-3685:

- (1) Disposable Gloves
- (2) Safety Goggles
- (3) Butcher Paper or similar material
- (4) Tool Kit
- (5) Paper Towels/Rags
- (6) Plastic Bags
- (7) Soap and Water

WARNING**RADIOACTIVE
MATERIAL**

The antireflective coating on the infrared optics contains thorium fluoride which is radioactive. The only potential hazard involves ingestion (swallowing or inhaling) of the coating material. Dispose of broken lenses, etc. in accordance with AR 385-11.

b. When removing the coated optical components, safety goggles and disposable gloves must be worn.

3-11. Operations.

The afocal assembly and optical imager are demilitarized using the following procedures:

a. Place butcher paper or similar material over the work area to prevent contamination of the area in the event a lens is broken.

b. Inspect the coated lenses for flaking of the coating or other signs of deterioration. If the lens coating shows signs of deterioration, wipe the surface of the optic with a moist cloth. Disposable plastic gloves shall be worn. These cleaning materials shall be placed in a

plastic bag and disposed of in accordance with AR 385-11.

c. Remove the coated optical lens from its assembly. Care shall be taken to avoid breaking the lens if the lens cannot be removed from its assembly, then the entire assembly shall be disposed of in accordance with AR 385-11.

d. In the event that a thorium-coated optic is broken, the following precautions shall be followed:

(1) Personnel in the immediate area who are not needed to clean the area shall be removed.

(2) The local Radiation Protection Officer shall be notified to monitor the clean-up operation.

(3) The immediate area where the lens was broken shall be considered a controlled area. Unauthorized personnel will not be allowed in the area until monitoring has indicated that the area is clean.

(4) The person surveying and cleaning the area will wear disposable plastic gloves.

(5) If the lens is broken on the work area that is covered with the butcher paper, place all the large pieces in a plastic bag and slowly fold the butcher paper together to enclose the remaining small particles inside. This must be done slowly to avoid making the smaller particles become airborne and thus increasing the risk of inhaling them.

(6) If the pieces of the broken lens fall on an area which is not covered with paper or plastic, place all the large pieces in a plastic bag and thoroughly vacuum the entire area, picking up all the small particles. Only a high efficiency (HEPA filtered) vacuum can be used for this purpose. Most shop vacuums do not qualify as high efficiency vacuums. If such a vacuum is not available, damp mopping is preferred. Dry sweeping shall be avoided. The area should be wiped with a damp rag, taking care to change the wipe surface so contamination is not spread. Always work from the least contaminated area into the most contaminated area. The rags, gloves, and other cleaning materials shall be placed in a plastic bag and disposed of in accordance with AR 385-11.

(7) All personnel involved will be monitored for contamination. Special attention will be given to monitoring their hands and bottoms of their shoes. All personnel will thoroughly wash their hands as an added precaution.

(8) The local Medical Officer and Radiation Protection Officer must be notified if decontamination of personnel is required.

e. Deleted.

f. Deleted.



**APPENDIX
REFERENCES**

AMC Safety Manual	AMC-R 385-100
Defense Reutilization and Marketing Manual	DoD 4160.21-M
Defense Demilitarization Manual	DoD 4160.21-M-1
Destruction of Classified Ordnance-Procured Items of Guided Missile Materiel	TB 9-298
Disposal of Excess, Surplus, Foreign Excess, Captured, and Unwanted Materiel	AR 755-2
Mechanical Accounting Procedures for Property Disposal Activities	AMC-R 755-3
Reporting, Utilization, and Redistribution of Installation, U.S. Army Materiel Command, and Overseas Command Excess Personal Property	AR 755-1
Requisitioning, Receipt, and Issue System	AR 725-50
Storage and Shipment of Supplies and Equipment	AMC-R 740-3
Department of Army Information Security Program	AR 380-5
Ionizing Radiation Protection (Licensing, Control, Transportation, Disposal, and Radiation Safety)	AR 385-11
Handling and Disposal of Unwanted Radioactive Material	TM 3-261
The Army Maintenance Management System (TAMMS)	DA Pam 738-750
Depot Maintenance Reference List for CHAPARRAL Air Defense Guided Missile System	DMRL 750-9
List of Applicable Publications (LOAP) for CHAPARRAL Air Defense Guided Missile System	TM 9-1425-585-L-1

By Order of the Secretary of the Army:

Official:

JOHN A. WICKHAM, JR.
General, United States Army
Chief of Staff

MILDRED E. HEDBERG
Brigadier General, United States Army
The Adjutant General

Distribution:

To be distributed in accordance with DA Form 12-32, Organizational Direct Support and General Support Maintenance requirements for the CHAPARRAL Missile System.

RECOMMENDED CHANGES TO EQUIPMENT TECHNICAL PUBLICATIONS



THEN... JOT DOWN THE DOPE ABOUT IT ON THIS FORM, CAREFULLY TEAR IT OUT, FOLD IT AND DROP IT IN THE MAIL!

SOMETHING WRONG WITH THIS PUBLICATION?

FROM: (PRINT YOUR UNIT'S COMPLETE ADDRESS)

DATE SENT

PUBLICATION NUMBER

PUBLICATION DATE

PUBLICATION TITLE

BE EXACT... PIN-POINT WHERE IT IS

IN THIS SPACE TELL WHAT IS WRONG AND WHAT SHOULD BE DONE ABOUT IT:

PAGE NO.	PARA-GRAPH	FIGURE NO.	TABLE NO.
----------	------------	------------	-----------

TEAR ALONG PERFORATED LINE

PRINTED NAME, GRADE OR TITLE, AND TELEPHONE NUMBER

SIGN HERE:

DA FORM 2028-2 JUL 79

PREVIOUS EDITIONS ARE OBSOLETE.

P.S.—IF YOUR OUTFIT WANTS TO KNOW ABOUT YOUR RECOMMENDATION MAKE A CARBON COPY OF THIS AND GIVE IT TO YOUR HEADQUARTERS.

